

Getting Started

CE Mode displays only velocity measurements. Internally, it stores and records temperature with each shot which is used for environment correction factor. If you need temperature values, you should switch to **CF Mode**.

If you are already familiar with chronographs, you can refer to "**Quick Start**" section on page 19.

CE & CF Mode displays the following data types:

- **Velocity in**
 - feet/sec
 - meters/sec
- **Battery power in**
 - Volts (measured internally under load)

CF Mode displays the following extra data types:

- **Energy for each shot**
 - Joules only, irrespective of units used.
- **Power Factor for each shot in**
 - Grains-Feet/Sec divided by 1000
 - Grams-Meters/Sec
- **Temperature for each shot in**
 - Fahrenheit
 - Celsius
- **Ambient temperature in**
 - Fahrenheit
 - Celsius

First Time User

If you are using chronograph for the first time, please note that the chronograph is an optical instrument and should be treated as such.

Excessive dust and dirt will affect accuracy and sensitivity.

How the chronograph works

Our chronograph is based on optics and it does not emit any harmful radiation, such as a radar chronograph would.

The principle of operation is very simple; two optical sensors, located at the bottom of the box, "look" through the slots on top of the unit. When the bullet passes over the first sensor, it blocks the light that shines down through the first slot.

This, in turn, starts the internal clock. When the bullet passes over the second sensor, located under rear slot, the clock is stopped. The internal computer knows the exact distance between the front and the rear slot; therefore, it can calculate the speed of the bullet using the elapsed time. The elapsed time tells the computer how long it took the bullet to travel from first sensor to the second one. Most of the chronographs operate using similar calculations.

Our chronograph has detection abilities that go far beyond ordinary chronograph. The unit has dual detection capability that can detect equally well moving shadows and moving reflections.

Also, our chronograph is the only product on the market that is able to notify you if it will work in your environment and whether it needs diffusers.

The most commonly used mode is **moving shadows**. You do not need to bother setting up any of these modes because it is all automatic.

The unit has 4 possible modes of operation:

- **Visible light, moving shadows**
- **Visible light, moving reflections.**
- **Infrared light, moving shadows.**
- **Infrared light, moving reflection.**

The unit can also function by mixing these modes during the same shot. Actually the unit selects the mode that produces the best results.

Light source required

There must be at least one of the following sources of light available for normal operation:

- **Visible light shining from the top.**
- **Visible light shining from the bottom.**
- **Infrared light shining from the top.**
- **Infrared light shining from the bottom.**

The chronograph adjusts itself to the changing light conditions. It will function from very dim light to a very bright light. When light source is from the bottom (*moving reflections*), it is desirable that it is as bright as possible, with no limit on brightness.

Fluorescent lights

The chronograph does not work if fluorescent lights are above or below the unit. The unit needs a flicker-free light source, which is a steady light, such as daylight. Fluorescent lights flicker at 2x60 or 2x50 cycles per second, depending on the country of origin.

Some new solid state fluorescent lights may flicker with frequencies that can exceed 10,000 cycles per second.

Fluorescent light source does not have to be directly over the chronograph to cause problems. The light may bounce off the walls, ceiling etc. To prevent this light reaching chronograph sensors, you need to block it out above the sensors. We will soon introduce solid state light fixture that will solve fluorescent light problems

Incandescent lights

A very bright incandescent light, about 60-Watts or more, shining directly into the optical slots will cause a problem. These lights do generate a very small amount of flicker that is picked up by the sensors when the intensity is very high.

Please note that we do not recommend using Archery mode with ordinary incandescent lights because the AC noise has to be filtered out.

With incandescent lights, you obtain the best results by using high power lamps, 100-Watts or more, reflecting off a white surface.

Preferable surface would be a white paper 4 to 8 feet above the sensors. Please see *"Setting Up"..."Indoors Setup"* page 22.

If your shot had a velocity of **938.54**, after ½ seconds delay the display will show:



This number remains displayed until you do something else; review stats, shots or fire a new round.

To view hidden lower digits, you must press and hold **<ENTER>** key. To change the units or check units conversion, just press **<UNITS>** key. See *"Changing Units"* (page 9).

Muzzle Blast

Muzzle blast from loud firearms can cause a false reading. This low cost unit does not detect muzzle blast 100% of the time, even with Sensor level set to 00%. Therefore, to prevent false triggering, you must place the unit far back from the firearm. Here are the recommended distances from the chronograph for various firearms and projectile launchers.

<u>Distance (feet)</u>	<u>Firing Device</u>
0	Archery
1	BB-Gun, Paint ball, Air rifle
3	Rim fire
4	Low caliber rifles
6	Hand guns
6	High caliber guns
8	Shot gun

If you experience false reading, you may have to move the chronograph even further away from the firearm. Use Sensor level reduction as a last recourse; see *"Muzzle Blast Control"*.

High value readings, flashing last digit

When displayed number exceeds **9999.99**, then last digit on the display will flash, indicating that you ought to look at the remaining low digits. This is irrespective of the units used. To view the low digits you simply press and hold down **<ENTER>** key.

When in **CE** mode or under PC control, you may not need to acknowledge calibration results if three bars are displayed after the number. The unit is in Auto-Calibration and it is ready to go.

Calibration failed

Flashing DOTS	Calibration failure has been detected. Sensors have been turned Off to conserve power and the unit will not accept shots.
Flashing COLON	Conditions are changing, the unit detected a problem and it will not accept shots. Sensors are turned Off to conserve power. You could try to calibrate again.

If all is well and you start measuring velocities, the following paragraphs describe how the unit will behave.

If the unit has no shots in it, when you press **<DATA>** key to place the unit in data view mode, display will show:



It says that there are **00** shots in memory, and you are in a chronograph mode. When the key is released, it displays velocity, and since there is nothing to display, it will show:



These four bars will be displayed until you fire a good shot.

When you fire the first shot, shot number will be displayed for a period of ½ seconds. In this case it would be shot number **01** and the display will show:



Light Diffusers

When using the unit outdoors, with very blue above, you need to use diffusers. Our diffusers are specifically designed to carry out two functions:

- **Evenly disperse intense light over the sensors**
- **Collect light from surrounding objects**

On a cloudy or hazy day there is no real need for diffusers. Diffusers can be used under any condition. It is recommended that they are to be used at all times, in order to increase unit's performance. If the sun is shining directly into the optical slots, then you definitely should use diffusers.

Basic Key Functions

The unit has 6 keys; some keys have multiple functions when held pressed. The display is a 4-Digits large LCD.



<u>Key Name</u>	<u>CE Mode Use</u>	<u>CF Mode Use</u>
<STATS>	Stats Mode & Next Stats	Set Stats
<DATA>	Data mode & Next Data	Set Data
<MENU>	Displays Model number	Go to Menu
<ENTER>	Displays lower digits	Same
<UNITS>	Changes units m-f	Next Data
<POWER>	Turns the unit On or Off	Previous Data

All these keys have different functions when pressed in conjunction with other keys. Two, three or four key functions are intended for advanced users.

Outdoor Calibration results	
Number Range	Explanations
512 to 1023	RF Interference, power lines, EMI or sodium lamps nearby.
300 to 511	Direct sunlight shining onto the sensors. Move the unit or use diffusers.
140 to 250	Very good condition.
000 to 100	Severe interference, very bad conditions

If a serious problem has been encountered, then **three dots** will be flashing very fast, indicating **calibration failure**.

For example, if the unit has detected fluorescent lights, then the display may flash between these two displays,



The three decimal points will flash independently and even faster.

If calibration failed, you could try again, and, if failure persists, you must remove the source of problem.

When calibration is finished, you must acknowledge calibration results by pressing <ENTER> or any other key. If you do not acknowledge it, then the unit will flash calibration results for ever and it will not accept shots. After you press any key, a final environment test is performed. This occurs very fast and it will not be noticeable.

If there is anything wrong with the environment following adaptive calibration, a flashing **COLON** will appear, indicating that the unit will not function under current conditions.

The unit will however still function, if the results of calibration are marginal; it is up to you to decide if you want to proceed.

When a significant interference or bad light condition is detected, the unit needs time to calculate and verify the effect it may have on velocity measurements. Depending on the type of condition, it could take up to **60** seconds to complete the job. When conditions are bad, all 3 decimal points on the LCD start to flash.

If you press any key before calibration is finished, the calibration is immediately terminated and **Calibration Failure** alarm is turned On. To remedy this, you must press **<ENTER>** key once to acknowledge the error and then recalibrate again by turning the unit **Off** and **On** again (**CE mode**). From CF mode press **<ENTER>** key again to start all over again.

When calibration scan is completed and setup is acceptable for normal operation, the display will flash between a final calibration **status-number** and calibration-command **[RL=]**.

For example, if calibration status was “+135”, the display will flash between **[135]** and **[RL=]**. No flashing decimal points indicate successful operation. In **CE** mode good results will display **[135=]**. The 3 bars indicate that the unit assumed that all is well and you may start shooting.

The number represents the quality of your light conditions as well as the type of interference found and how severe it is. Here are typical results for indoors and outdoors,

Indoors Calibration results	
Number Range	Explanations
512 to 1023	Fluorescent lights are overhead or Incandescent lights are very strong.
300 to 511	Fluorescent & Incandescent lights mixed or other interference.
140 to 200	Very good condition
000 to 100	Severe interference, very bad conditions

Data Mode <DATA>

When this key is pressed, the unit switches to **Data Mode**. In this mode the unit remembers your last data position. Each time you press **<DATA>** key, it displays next shot. You can review your entire string by pressing this key.

When you press **<DATA>** key, the display will show your current data view position. For example, if last time you were reviewing shot number **03**, then this number will be displayed while you hold **<DATA>** key down. When you let go, then the actual velocity value will be displayed.

If you have just fired a shot, this takes precedence over your last data pointer. For example, if you have just fired a load number **8**, the data view is forced to number **08**, irrespective of your last view position. Display will show:



The two lower bars on each side indicate that you are in a **Chronograph** mode. This number is displayed as long as you hold down **<DATA>** key. If you release this key, then the velocity is displayed. For example, if your velocity was **386.87** the display will show:



If you want to view the remaining digit, which is number **7**, you press and hold **<ENTER>** key. The remaining digits stay in view as long as you hold down **<ENTER>** key. For example in this case the display will show:



When you release the **<ENTER>** key, the display returns back to normal, i.e., to **386.8**. We strongly recommend that you try CF-Mode because it scrolls data and stats like a spreadsheet.

Stats Mode <STATS>

When **<STATS>** key is pressed, the unit switches to **Statistics Mode** and it will remember your last statistics position.

To use statistics you do not need a full string. Statistics can be used anytime as long as there is more than one shot in memory. Statistics are calculated in real time. Therefore, when in Stats Mode, you will see the updated results immediately as new shot is fired. Statistics display has no visible delay.

Statistics List

Each time you press **<STATS>** key, the statistics scrolls forward. While the key is held pressed, the display shows stats identifier as listed below. When this key is released, then statistics calculation is displayed. Available statistics are listed below, in the order as they would appear:

<u>Identifier</u>	<u>Statistics Description</u>
<u>_Lo_</u>	Low value , Finds the lowest value
<u>_Hi_</u>	High value , Finds the highest value
<u>_Av_</u>	Average value , Calculates average value
<u>_ES_</u>	Extreme Spread , Calculates highest minus lowest
<u>_Sd_</u>	Standard Deviation , Calculates standard deviation
<u>_Pd_</u>	Percent STD , See Percent Standard Deviation
<u>_Fo_</u>	Total shots , Total number of shots in the string
<u>_PF_</u>	Power Factor , (Grains-f/s)/1000 or Grams-m/s
<u>_En_</u>	Energy , Joules, regardless of units used

When you press **<STATS>** key, current statistics identifier appears. For example, if your last location was **Low Value**, then the display will show

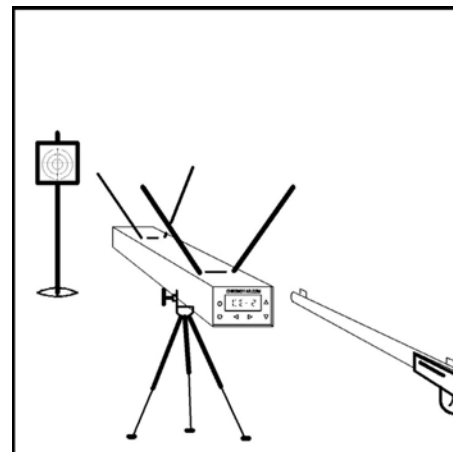

Without Diffusers

If the sky is overcast and it looks milky white, you do not need diffusers. However you must verify that the unit will function without diffusers. To verify this, please read **"Run Calibration"** section below. Calibration results must be between 000 and 200 for the unit to function well without diffusers.

Run Calibration

After the unit has been set up, you are ready to test the light conditions.

From **CE** mode, if the unit is **On**, turn it **Off** and **On** again by pressing **<POWER>** key. From **CF** mode, press **<MENU>** then **<ENTER>** key.

The unit will now go through adaptive calibration, and display will show rapidly moving number. This number represents calibration status. It can go from **000** to **1023** and it may take as long as **60** seconds to complete. If environment is very good, it only takes about **10** seconds.

This is not an ordinary chronograph but the first generation of smart chronographs. Adaptive calibration scans for a broad range of light conditions and interference sources to calculate optimum setup. The calibration process and setup is rather complex and is beyond the scope of this manual.

Typical sources of interference that the unit will track are: fluorescent lights, flickering bulbs, sodium lamps, airborne sand drifts, airborne snow drift, birds, strong radiofrequency (RF) signals, AC power lines and any EMI source.

If the light conditions are good and there are no sources of interference, the scan is completed in less than **10** seconds.

Indoors Setup

Install diffusers as shown and two 40 to 60 Watts light bulbs about 2 to 4 feet high from the diffusers. If you use flood lights, then a single 100-Watt bulb, 4-feet above the center of unit would

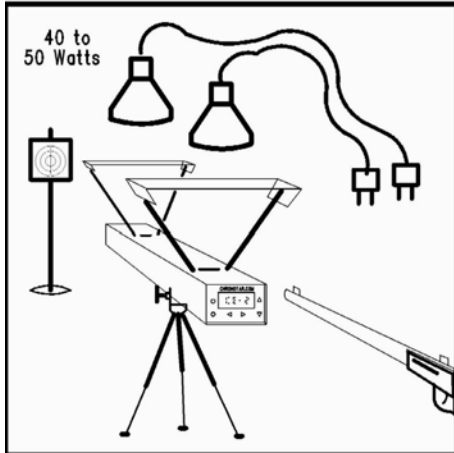

be sufficient.

Infrared lights are the best. If you have a white ceiling, then use two 150-Watts flood lights pointing up to the ceiling above each optical slot. The ceiling should not be over 10-feet high. The whiter the ceiling, the higher it may be. When using this method, diffusers are not required.

Avoid using solid state dimmers because they

generate a lot of electromagnetic interference (EMI) that may cause problems. Adaptive Calibration will reduce sensitivity level when EM radiation is detected from these dimmers.

Outdoors Setup

For outdoors you do not always need diffusers. If they obstruct your view and you prefer not to use them, then you must run calibration function to determine whether you need them or not. This is described in "*Run Calibration*" (see section below)

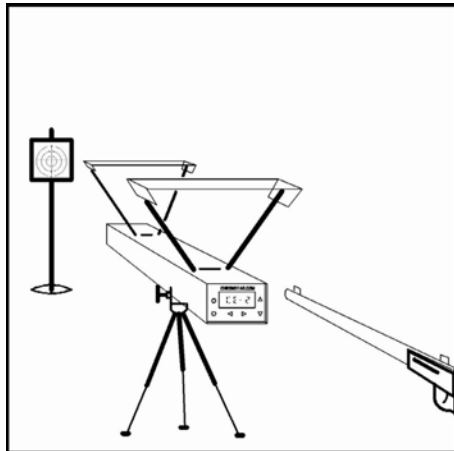

With Diffusers

Set up the unit as shown on this picture. You normally do not need diffusers; however, you should use them if possible. They provide a uniform source of light for accurate measurement. On a darker day or when the sky is very deep blue, diffusers have the ability to collect light from surrounding area.



The two lower bars on each side indicate that you are in a Velocity mode. This identifier is displayed as long as you hold down **<STATS>** key. When you release this key, then actual lowest velocity is displayed.

For example, if your lowest velocity was **135.37**, then the display will show,



If you want to view the remaining low digits, in this case number **7**, then you press and hold down **<ENTER>** key. The display will show:



Each time you press **<STATS>**, the statistics advance to the next position. When the end is reached, it then loops back to the beginning. We strongly recommend that you switch to CF-Mode because it scrolls data like a spreadsheet. CF Mode can also do cross-string statistics; that is, you can compare stats between strings instantaneously.

Percent Standard Deviation (Pd)

Standard deviation is an incomplete representation of measured data behavior. In order to obtain a meaningful number you have to combine Standard Deviation with another Stat result, such as the Average Value.

Here is an example of a typical problem. Let us assume that you fired two strings with 5 shots each at different velocity ranges. In the example below all values are in feet/sec,

Shot Number	String-1 1020-f/s Range	String-2 120-f/s Range
1	1010.00	110.00
2	1015.00	115.00
3	1020.00	120.00
4	1025.00	125.00
5	1030.00	130.00
Average Value	1020.00	120.00
Standards Deviation	7.9056	7.9056
Percent Deviation	0.7750	6.5880

As you can see, **String-1** and **String-2** have the same **Standard Deviation**, yet you know that shots in **String-2** are much worse. In order to solve this problem, we have provided a formula for **Percent Standard Deviation**, which is defined as:

$$\frac{(\text{Standard Deviation})}{(\text{Average Value})} \times (100)$$

This is a far **superior** performance indicator of your shots. According to our calculations, **String-2** is worse than **String-1** by a factor of:

$$\frac{(6.5880)}{(0.7750)} = 8.500$$

Standard deviation (**STD**) alone would never reveal this problem because both strings would have the same **STD** number.

For those who insist on using Standard Deviation, we still provide that value for compatibility with old chronographs.

There is another set of error messages that may appear as **Prrr1**, **Prrr2**, or **Prrr3**. These alarms are very **serious**, cannot be **ignored** and indicate battery voltage status:

- Prrr1** Battery is low, performance will degrade
- Prrr2** Battery is too low for normal operation
- Prrr3** Battery is dead, it should be replaced

For further details see "**Alarms & Errors**"... "**Battery**" (page 10).

If the unit has previously been used and it still has a battery in it, then you just press **<POWER>** key to wake up the unit. If the unit does not wake up see "**Troubleshooting**"... "**Dead Unit**" (page 52).

It is easier to check the unit before it is set up. It is also a good practice to check battery power level before you start shooting session. The battery level is checked with **<ENTER+POWER>** keys. The value is displayed only while you hold down both keys. It displays battery voltage and it should be greater than **7.00** volts.

The unit will still work at 6.0 volts but the performance is degraded. You may still use the unit on a low battery, as long as you keep in mind that below 7.00 volts you will start getting low battery alarms.

Quick setup

You are now ready to set up the unit; chose any of the setting below that matches your needs. If you do not have a tripod, you can use any surface, table, stool etc. The only requirement is that the unit should be aligned with your shooting sight. Whatever you do, do not shoot the unit because it will be destroyed. You have to shoot 4 to 12 inches above the unit. Use the black rods as a guide. Loud firearms generate a muzzle blast which may cause problem, see "**Muzzle Blast**" (page 27).

Reset & First Time Power On

After battery is installed, the unit goes through a self test. This also happens when **<DATA+STATS+MENU>** keys are pressed, which resets the unit. The test is only performed once and it is not done when the unit is turned Off and On using **<POWER>** key. It takes approximately 12 seconds to complete this test. During this time all the elements of LCD are displayed as follows,



These elements are then cleared one by one, until LCD is blank as shown below,



This process is slow enough to allow the eye to observe and inspect each element as it is cleared. There are other internal tests, but they are not visible to the user. Any key pressed during the LCD tests aborts them immediately.

When the unit is ready for the first time, it will display the model number. For example **CE-3** will be displayed as follows,

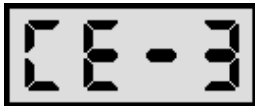

Verify Operation

After all the tests are done, a quick internal calibration makes the unit ready for shooting. If the light conditions are not right, then the unit may give one of the following flashing error messages:





These errors generally appear if the calibration command has not been executed yet and the light conditions are bad. For now these messages can be ignored.

Menu & Model number <MENU>

When **<MENU>** key is pressed, display will show current mode and model number. For example, if you are in **CE** mode and this is **CE-3** model, it will be displayed as follows:



When the key is released, it returns back to the last display mode, which is either **DATA** or **STATS** view. This key brings up Menu when in **CF Mode** and displays the very first menu in the entry. For example Data menu is  and Stats menu is .

Lower digits view <ENTER>

This function displays the lower hidden extended digits. The unit displays results up to two decimal points. Whatever does not fit into a 4-digits display, it can be viewed with this function.

Extended Digits

The unit has 8-digits computation accuracy and it only displays the first most significant 4 digits. To see the remaining 4 digits you press and hold down the **<ENTER>** key. When you release this key, it returns back to normal display.

If there is no decimal point displayed, either in normal view or when 4 lower digits are viewed, then this implies that the decimal point is at the end of normal view.

For example:

If the velocity is **1938.54**, then the display will show **1938**. When **<ENTER>** key is pressed, then **54** will be displayed. This indicates that the decimal point is after number **1938**.

Next Shot & USA-Metric Conversion <UNITS>

In **CF Mode**, this key moves to the next shot. In **CE Mode** this key switches from **USA** to **METRIC** units, and vice versa. It is always active and you can do units conversion check any time. USA units are feet/sec and METRIC units are meters/sec. If you were using USA units, it will switch to METRIC units. If you were in METRIC units, it will switch to USA units.

Here is an example of how this is used. Let us assume that you just fired a shot and the number was **08** with velocity of **938.54** and you were using **USA** units. The display will show



for about ½ seconds. The two lower bars on each side indicate that this is a velocity data mode. The absence of dots on each side of the number **08** indicates that you are in **USA** units.

Following a ½ second delay, the velocity value is displayed as follows,



When you press and hold down **<UNITS>** key, it switches to metric units. This is indicated by the following display,



which indicates METERS mode. The two dots are METERS indicators and are also displayed with shot number and stats identifier.

When you release the key, the converted value will be shown. In this case it will be **286.06** and the display will show:



Quick start

This device is an optical instrument, therefore dust and dirt will affect its operation. We strongly recommend that you treat it with the same respect as you would a digital camera.

Unpack the unit and install a new 9-Volt battery

Note:

Battery voltage must not exceed **10 Volts** at any time, because this may **destroy** the unit.

If the unit does not start, use “Hardware Reset” feature. This is done by pressing **<STATS+DATA+MENU>** key. If this does not work, **check battery voltage**. See **”Troubleshooting”...”Dead unit”**

The unit will detect shots **properly** only if the battery voltage is **above 7-Volts**. If the battery is less than **7-Volts**, it should only be used for Data or Stats retrieval & review, even if it still detects shots.



Most chronographs appear dead if the battery voltage drops below **6.5-Volts**. Our unit still functions for Data review even when the voltage drops below **4.6 volts**.

Please note: when battery power alarms come on, it is necessary to replace the battery, because the unit will no longer detect shots as intended.

You may still download data to PC when battery alarms come on. To conserve power, turn sensors off with <MENU+POWER> keys and use short interface cable, 16-foot maximum. Longer cables will degrade communications signals

Battery power alarms:   

Calibration Status Results

Calibration status number is indicated by the flashing display that follows calibration completion. For example, if calibration status number was **135**, then the display will flash between  and . In Auto-Calibration mode display will not flash, instead number **135** with 3 bars is displayed: . This is true only when unit thinks that the environment is acceptable. Please keep in mind that CE-3 has a limited intelligence.

Indoors calibration status numbers

- 512 to 1023 Fluorescent light overhead or strong EMI.
- 300 to 511 Marginal conditions
- 140 to 300 Functional range
- 000 to 100 Severe interference

Outdoors calibration status numbers

- 512 to 1023 Bad environment
- 300 to 511 Marginal Conditions
- 140 to 250 Functional range
- 000 to 100 Severe interference

Flashing Decimal Points

- Fluorescent lights overhead or other light interference
- Electromagnetic interference or unit is moving.

If you press the **<UNITS>** key again, the display will switch to **USA** units. In this case it will show **USA** units identifier as follows,



When you let go of the **<UNITS>** key, it returns back to showing the velocity in **USA** units, feet/sec:

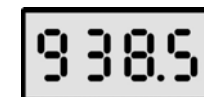



You can switch back and forth without affecting the internal results or memory. You can either do a quick, on the fly conversion check, or you can return to your desired units.

Previous Shot & Turn Unit On-Off <POWER>

In **CE Mode** this key turns the unit **On** if it was **Off**, and **Off**, if the unit was it **On**. To save power, you should always turn the unit **OFF** while you are setting it up or is not being used. There is auto-power-off but it takes 30 minutes to kick in. The auto-power-off time can be set from Stats menu or disabled altogether.

In **CF-mode** this key is **<Up>** key; it scrolls data or stats up. This key moves one shot back.

When the unit is **Off** and you press **<POWER>** key, the display will show , indicating that it is about to go to sleep. You can then release the key. If you subsequently touch **<POWER>** key, the unit wakes up again with the display showing  greeting and goes into Adaptive Calibration. You can continue with your work where you left it.

In **CF-mode** the unit goes to Data menu to remind you that it has to be calibrated. The sensors are turned **Off** until you decide what to do next. You can either exit to Data, Stats, data manipulation, or you can calibrate the unit and start shooting session from the spot you last finished.

EXTENDED KEY FUNCTIONS

For advanced users we have provided extended functions. These are accessible when one or more keys are held pressed. If you find this method cumbersome, you should consider switching to CF-Mode for a menu driven system.

If two keys have to be pressed, you press and hold the first key and then press the second key.

When three key have to be pressed, the first key is pressed and held down. The second key is pressed while the first is still held down. Finally you press the third key while the first two are held down. You cannot waver by letting go of first or second key, they all must be held pressed.

Battery power level <ENTER+POWER>

This key combination displays battery power level in volts. This is an internal value measured when the battery is loaded. The value is displayed only while you hold down both keys. It will always be less than open circuit measurement, performed with a voltmeter, when the battery is taken out of the unit.

Sensitivity Level <ENTER+UNITS>

This sets sensitivity level in steps of **5%**, from **00%**, the lowest sensitivity to **95%**, the highest setting. This determines how easily the units detects your shot. Factory setting is **60%** for moderate muzzle blast reduction.

If you are not using loud firearms, we recommend that you change sensitivity to **75%** or higher. The higher the sensitivity, the more accurate the unit becomes. Unfortunately higher values do cause problems with Muzzle blast, fluorescent lights and other environmental noise.

Muzzle blast reduction is hard to define because human hearing does not cover broad spectrum that will impact the unit. For example, our chronograph will be affected by the frequencies from 1-Hz to 80,000-Hz. Muzzle blast contains a complex range of frequencies; the chronograph can detect sounds beyond human hearing range.

<u>User – Stats menu</u>		EXE	INC	DEC
	Display CAM level, CAM-1 or CAM-2	x		
	Minimum Stats Displayed, On - Off	x	x	x
	Auto Power Down Enabled , On - Off	x	x	x
	Auto Power Down time, 00:00 to 03:51	x	x	x
	Professional Mode, On - Off	x	x	x
	Slow Down Changing Display, On - Off	x	x	x
	Return to the Last menu Location , not first entry	x	x	x

<u>CAM – Stats menu</u>		EXE	INC	DEC
	Set CAM Test Mode, On - Off	x	x	x
	eDisk Enabled, On - Off	x	x	x
	Communications Delay, On - Off	x	x	x
	ALL Enabled, CAM factory tests .	x	x	x
	OCO Enabled, CAM factory tests .	x	x	x

Statistics List

Statistics needs more than one shot; it does not need a full string.

	Low	The lowest value found
	High	The highest value found
	Average	Average value
	Extreme Spread	Highest value minus lowest
	Standard Deviation	Uses population (n-1)
	Percent STD	Percent standard deviation (n-1)
	Total shots	Total shots in the current string
	Power Factor	Power factor, CF-Mode only
	Energy	Energy, CF-Mode only

<u>System – Stats menu</u>		EXE	INC	DEC
POF	Turn unit off and save Status & Data to eDisk	x		
SOF	Turn Sensors Off , Save power during data review	x		
PVL	Display Battery Voltage , internal load point	x		
Mod	Display Model Number	x		
S, r	Display Serial Numbers , Lower, Middle & Upper	x	x	x
Ver	Display Software Version Number	x		

<u>Stats – Stats menu</u>		EXE	INC	DEC
SLL	Display Stats Location of “High” or “Low”	x		
Loc	Go to the location of “High” or “Low”	x		

<u>String – Stats menu</u>		EXE	INC	DEC
Snn	View and Set String Size to 4,5,6,7,8,9,10 Shots	x	x	x
C, r	Data increment to Circular mode On - Off	x	x	x
M, c	Manual Data Increment mode On - Of	x	x	x

<u>Chrono – Stats menu</u>		EXE	INC	DEC
C, r	Turn Chronograph Sensors On - Off	x	x	x
FRF	Fast Fire mode On - Off	x	x	x
SNO	SMO Type, CAM factory tests	x	x	x
SLE	SLE Value, CAM factory tests	x	x	x
HCO	HCO Enabled, CAM factory tests	x	x	x

<u>Error – Stats menu</u>		EXE	INC	DEC
E, r	Display current error number	x		
ELC	Maximum Errors allowed count, 00 to 255	x	x	x
H, r	Hold Errors Displayed, On - Off	x	x	x
M, r	Memory overflow errors, On - Off	x	x	x
P, r	Repeat Battery Low alarms, On - Off	x	x	x

We strongly recommend that you use muzzle blast reduction by reducing sensitivity as a last resort. This low cost unit, like most of the chronographs on the market, has a PVC housing which does not resist muzzle blast very well.

High sensitivity in combination with “Super Archery mode” will allow you to detect Archery and Pinball beyond 4 feet height. However, at those heights the accuracy diminishes greatly because of PVC housing material. Our specifications are only valid at height of 6 inches.

If you set sensitivity too high for your environment conditions, Adaptive Calibration will detect the problem, turn sensors off and give you calibration alarm.

Example of setting sensitivity to **80%**. When **<ENTER+UNITS>** is pressed, sensitivity is incremented by **5%**. If your last setting was **65%** then it will increment to **70%** and display will show:



Once you reach **95%**, it loops back to **00%**. Please note that the unit will remember this setting as long as the battery is not removed. In **CF** mode your settings are remembered as long as eDisk does not fail.

Please note: when Sensitivity level is changed with this command, the sensors are turned off and the unit must be calibrated again.

CF mode provides a fine control of sensitivity in steps of 1% from **SLL** under **CRS** menu.

Delete shot <ENTER+POWER+DATA>

This key combination clears current shot number from memory. The number that will be deleted is the one that shows up when **<DATA>** key is pressed. Display will show shot deletion in progress.

For example, to delete shot number **08** you press **<DATA>** key until **08** is displayed. From **CF** mode just use scroll keys to locate the shot you want to delete.

Display will show the following sequence: `[CLR]`, followed by `[Sho]` and finally `[08]`. This confirms that shot number **08** has been deleted. When the keys are released, display shows `[07]`, the next shot in the string that you can delete.

Undo Deleted Shot <ENTER+POWER+MENU+DATA>

This key combination reverses the deleted shot operation. When shot is deleted, it is moved into the trash bin. This function finds the old shot in the trash bin and puts it back.

Example: undelete shot **08** from the example above. When the four keys are pressed, display shows the following sequence: `[Undo]`, followed by `[Sho]` and then `[07]`, indicating your current data location. When the keys are released, `[08]` is displayed, indicating the shot that was restored. With this command you can delete-undelete only one shot at a time; consequently, you can only undelete your last deleted shot.

CF-Mode allows unlimited delete-undelete operations from Data menu `[Sho]...[CLR]...[Unde]`. If you delete a shot, add a new one and undelete, restore sequence is lost. There is a way to get around this: use **Data Recovery** function (page 43), which restores all shots found in the trash bin irrespective of the order.

Clear String <ENTER+POWER+STATS>

This key combination clears current string. The old shots are not really lost, they are simply moved into the trash bin. When these keys are pressed, display shows your string number and number of shots in it that were deleted.

For example, if your memory had **05** shots in string **01**, then the display would show `[CLR]` followed by `[Str]` and then `[0:05]`. This confirms that string **01** with **05** shots in it was deleted. When you release the keys, display shows your current string and number of shots in it. In this case: `[0:00]` - string **01** with **00** shots.

If you change your mind, you can undo Clear String with **Undo Clear String** command in the next chapter.

<u>eDisk – Data menu</u>		EXE	INC	DEC
<code>[dDr]</code>	Display Current Disk drive and Folder used	x		

<u>Com – Data menu</u>		EXE	INC	DEC
<code>[Con]</code>	Communications Baud Rate 300 to 4800	x	x	x
<code>[dLF]</code>	Download Folder – Forced Send	x		
<code>[dLR]</code>	Download All folders , Entire eDisk, Forced Send	x		
<code>[dLH]</code>	eDisk Memory Dump , Test mode, Forced Send	x		

STATS Menu list

<u>System</u>	<u>Stats</u>	<u>String</u>	<u>Chrono</u>	<u>Error</u>	<u>User</u>	<u>CAM</u>
<code>[POF]</code>	<code>[SLL]</code>	<code>[Snn]</code>	<code>[Crr]</code>	<code>[Err]</code>	<code>[U..]</code>	<code>[CRN]</code>
<code>[SOF]</code>	<code>[Loc]</code>	<code>[Cr]</code>	<code>[FAF]</code>	<code>[Elc]</code>	<code>[N..n]</code>	<code>[Edd]</code>
<code>[PLL]</code>		<code>[N..c]</code>	<code>[SNO]</code>	<code>[Hrr]</code>	<code>[Pdc]</code>	<code>[Cdd]</code>
<code>[Mod]</code>			<code>[SLE]</code>	<code>[Nrr]</code>	<code>[Pdo]</code>	<code>[ALL]</code>
<code>[S.r]</code>			<code>[HCO]</code>	<code>[Prr]</code>	<code>[Pro]</code>	<code>[OCO]</code>
<code>[Son]</code>					<code>[Sd.]</code>	
					<code>[PnL]</code>	

Any changes made in this menu will affect unit's operation.

The following functions: `[Sd.]`, `[PnL]`, `[Edd]`, and `[Cdd]` appear only when **CAM** mode is turned on from `[CRN]` menu.

The following functions: `[SNO]`, `[SLE]`, `[HCO]`, `[ALL]`, `[OCO]` are for service personnel and factory use only. If you activate them, please do not change their setting. If they are accidentally changed, do the following in order to restore them: from CE or CF mode, press **<MENU+POWER>** key to save your work on eDisk. Then press **<DATA+STATS+MENU>** keys to reset the unit and make sure you release **<DATA>** and **<STAT>** key first.

Shot – Data menu

		EXE	INC	DEC
SHO_	Display next-pending shot location in the string	x		
CLR_	Clear current shot	x		
UNC_	Restore last cleared shot	x		

String – Data menu

		EXE	INC	DEC
SRN_	Display String number and size	x		
dEL_	Delete current string	x		
Und_	Undo last string delete	x		
UNO_	Restore Old shots from trash bin	x		

Folder – Data menu

		EXE	INC	DEC
FOL_	Select folder, scroll Forward & Backward	x	x	x
dEL_	Delete folder	x		
Und_	Restore deleted folder	x		
SRU_	Save Current Folder to eDisk	x		
FR_	Free Space in the Folder, number of shots	x		

Error – Data menu

		EXE	INC	DEC
ERR_	Display Current Error (Crr, Prr, Mrr, Orr)	x		
MOR_	More errors, (Prr, etc.)	x		
ERC_	Total Error Count (Crr errors only, page 10)	x		
CLR_	Clear all errors	x		

User – Data menu

		EXE	INC	DEC
UC1_	Display CAM level, CAM1 or CAM2	x		
BAA_	View Battery Voltage, After internal load	x		
CEL_	View Ambient Temperature in Celsius	x		
FAH_	View Ambient Temperature in Fahrenheit	x		

Undo Clear String <ENTER+POWER+MENU+STATS>

This key combination restores the effect of clearing last string. String delete does not really delete the string; the contents are just moved into the trash bin. Undo clear string restores old shots saved in the trash bin back to the memory.

This example restores string number **05** deleted in the previous chapter. When the keys are pressed, display sequence will show **Undo**, followed by **SRN**, then **0:00**, indicating string **01** will be restored. When all the keys are released **0:05** is displayed, indicating that **05** shots were restored in string number **01**

Data Recovery

There is command in CF Data menu, **UNO** (see pages 13,14), that restores all the contents found in the trash bin back to the string. This is intended for emergency only when, for example, shots were deleted during sorting them out.

This command is only available from **CF** mode. Switch the unit to **CF** mode, press **<DATA>** key to get **CLR** menu, press **<MENU>** two times to get **SRN** menu, press **<UNITS>** three times to get **UNO** menu.

It may be necessary to delete unwanted shots, one by one, with **<MENU+DATA>** key function. The system cannot differentiate between bad and good shots; it restores all of them. The shots are restored back to memory in a correct sequence.

Sensors Off <MENU+UNITS>

This key combination turns Off all environment-monitoring sensors. When these keys are pressed, display shows **EOFF**, indicating that chronograph velocity capture is Off.

By disabling velocity measurement and turning **Off** all environment alarms, the unit saves battery power by about **50%**. You can however perform other functions such as data and stats reviews. In order to activate velocity measurement again, the unit must be calibrated.

DATA Menu list

<u>System</u>	<u>Shot</u>	<u>String</u>	<u>Folder</u>	<u>Error</u>	<u>User</u>	<u>Com</u>	<u>eDisk</u>
[CAL]	Sho	Srn	Fol	Err	Ucl	Con	ddr
Arce	Clr	dEL	dEL	Nor	bAA	dLF	
SLL	Unc	Und	Und	Err	CEL	dLA	
bUL		Uno	SAU	Clr	FAH	dLH	
_NE			Fr				
_CE							
USA							
NEC							
CRP							
Lcc							
FLL							

Some menu functions appear only when **CAM** mode is turned on with [CAM] menu (see page 15). These are: [Lcc], [FLL] and [dLH]. Data menu does not have setup parameters that may cause serious problems. From Data menu you can only manipulate data-related setup.

Only Stats Menu permits Setup changes

<u>System – Data menu</u>		EXE	INC	DEC
[CAL]	Run Adaptive Calibration	x		
Arce	Archery mode, On - Off	x	x	x
SLL	Sensitivity level control, 00% - 99%	x	x	x
bUL	Bullet mass , maximum 631.95-grn, 40.950-gm	x	x	x
_NE	Meters/Sec , On - Off	x	x	x
_CE	Temperature in Celsius , On - Off	x	x	x
USA	Persistent-always Imperial units , On - Off	x	x	x
NEC	Persistent-always Metric units , On - Off	x	x	x
CRP	Run Calibration Interference meter, test mode	x		
Lcc	Long Calibration , On – Off, CAM-2 Only	x	x	x
FLL	Fine Sensitivity control, 0.0 -100.0%, CAM2 Only	x	x	x

Switch between CE and CF mode <MENU+ENTER>

This key combination flips between **CE-Mode** and **CF-Mode**. It does not change user's setup, data or eDisk.

We strongly recommend that you use **CF** mode, because eDisk handles data with far better safety and reliability. Only **CF** mode uses automatic data storage & retrieval. **CE mode does not use eDisk at all**. However, you can force **CE** mode to store current folder onto the eDisk by turning the unit Off with <MENU+POWER> keys.

The unit will display the mode that is switching into. If you are in **CF-Mode**, it will switch into **CE-Mode**, and the display will show:

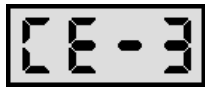

You know that you are in **CF-Mode** when you press <MENU> key and the model number does not show up; instead the first menu header is displayed: [CAL] in **DATA menu** and [POF] in **STATS menu**. When in **CE-Mode**, the model number [CE-3] will be displayed instead.

Find Stats-Shot <DATA+STATS>

This key combination finds the location of the **Lowest** or **Highest** value in the string. If Stats is set to [Lo], it will go to string location representing low value. If Stats is set to [Hi], it will find high value location. Shot's position is only displayed while you hold down both keys. To view the actual values, just press Data key; you will get both, the value and its location.

In **CE** mode, this function can be confusing if you subsequently press <DATA> key many times, because <DATA> key scrolls to the next shot position in the string. **CF-Mode** does not have this problem because it uses a uniform-menu driven interface.

Increment String <DATA+ENTER>

When you press and hold <DATA> key, followed by pressing <ENTER> key, your current string number and number of shots in it are displayed.

CF Menu

There are two menus; **Data** menu for data manipulation and **Stats** menu for **Setup** and **Control**.

CF Menus are available only from **CF** mode; therefore, the unit must be flipped to **CF** mode with **<MENU+ENTER>** keys. The unit is in **CF** mode if **[CLR]** or **[PDF]** is displayed when **<MENU>** key is first pressed. If **[E-3]** is displayed, it indicates that the unit is still in CE mode.

To get to Data menu, press **<DATA>** key. Pressing **<MENU>** key brings up the first Data menu; display is **[CLR]**.

To get to Stats menu, press **<STATS>** key. Pressing **<MENU>** key brings up the first Stats menu; display is **[PDF]**.

Menu Movement and Control keys

<u>Keys</u>	<u>Name</u>	<u>Action</u>
<MENU>	<Left>	Main menu <i>left</i>
<MENU+DATA>	<Right>	Main menu <i>right</i>
<UNITS>	<Down>	Submenu <i>Down</i>
<POWER>	<Up>	Submenu <i>Up</i>
<ENTER>	<Exe>	<i>Execute</i> menu or view results
<ENTER+POWER>	<Inc>	<i>Increment</i> value or flip value
<ENTER+UNITS>	<Dec>	<i>Decrement</i> value or flip value

When modifying large numbers such as Bullet mass in **[bul]** menu, you can use auto increment or decrement feature. When **<Inc>** or **<Dec>** is held pressed, number starts to increase or decrease faster and faster. The longer you hold these keys down, the faster the number will change. When you let go of the keys, it slows down again. This way you can set your number to any large value without much trouble. When the keys are released, unit returns to the same menu.

Value that can be modified is viewed by pressing **<Exe>** key and it is displayed as long as you hold down this key. When the key is released, unit returns to the same menu.

For executable functions, such as clear shot, execution progress is displayed, before it returns to the same menu.

For example, if your current string number was **01** with **5** shots in it, the display will show:



If the string is empty, display will show **[0:--]** instead. To move to the next string, hold down **<DATA>** key and use **<ENTER>** to increment string number.

The first time you press these keys, it does not move to the next string but displays your current string. By pressing these keys again, it moves to the next string.

Decrement String <DATA+MENU>

This function is the opposite of the **Increment String**. It allows you to move to the previous string.

Cross String Stats <STATS+ENTER> & <STATS+MENU>

When you press and hold **<STATS>** key followed by pressing **<ENTER>** key, stats pointer and the string number is displayed. For example, if the last stats viewed was **Low** value and the string number was **01** then the display will show,



This indicates that you are now viewing **Low** value for string number **01**. When **<ENTER>** key is released, the actual low value is displayed. This works with all statistics commands.

NOTE

The first time you press **<ENTER>** key, while holding down **<STATS>** key, current string is displayed. Subsequent pressing of **<ENTER>** key, while holding down **<STATS>** key, automatically increments string number by one.

For **Cross-String Statistics** comparison, hold down **<STATS>** key and use **<ENTER>** key to move from string to string. When **<ENTER>** key is released, while still holding **<STATS>** key down, your string statistics are displayed. With this method you can check and compare your entire string set.

Archery On-Off <ENTER+POWER+UNITS>

This key combination flips from normal mode to archery mode and vice-versa. This difficult key combination has been chosen on purpose to prevent accidental switch to/from archery mode.

For example, if the unit was in **normal mode** and this function is executed, the display would show:



indicating that the unit has flipped to **archery mode**.

Similarly, if the unit was in **archery mode** and this function is executed, the display will show:



indicating the unit is now in **normal mode**.

Whenever the mode is changed, the unit will turn on calibration alarms and bad environment alarms. Flashing **colon** and flashing **decimal** points indicate that you *must calibrate* the unit again.

Power-Up Features

Pressing and holding **<DATA>** key, prior to turning the unit on, prevents data or setup information to be loaded from eDisk into the memory. This feature may be used to reset the unit's setup to factory default.

Hardware reset may also be accomplished by pressing **<STATS+DATA+MENU>** keys. When these keys are used, slowly release all the keys except **<DATA>** key; it has to be released last. The unit will confirm this option by displaying the following.



To save this **Default Setup** onto the eDisk, press keys **<MENU+POWER>**. This is a forced power Off with Data and Status saved to eDisk. Both **CE Mode** and **CF Mode** have access to this command. This is the only time when **CE Mode** is permitted to use eDisk. **CF Mode** handles eDisk automatically.

Memory Overflow Errors

When the string is almost full, a warning alarm comes on. This is a user option that must be set within **CF** mode first. **CE** default at start-up is a simple interface with these alarms disabled. The unit tracks data history and only the oldest shots are overwritten first. Circular mode has this alarm disabled.

 Memory is full, there is no more room. If you fire more shots, then the oldest ones will be lost.

 You have room for one more shot in this string

Displayed value has no decimal point

If there is no decimal point showing, even when **<ENTER>** key is pressed, it implies that the decimal point is after the fourth digit. For example, numbers **1000.00** to **9999.99** and **1000.000** to **9999.999** will have no decimal point displayed.

CF mode

This is an advanced mode that provides full control over data manipulation and environment settings. This mode uses scroll keys and menus; a far better system than multi-key operations. This mode is selected with **<MENU+ENTER>** key and it provides over **70** functions. **CF-Mode** has easier access to cross-string statistics, power factor, energy etc.

Please note: when **CE-3** detects remote control requests from PC, it automatically switches to **CF** mode. It stays that way until it is flipped to **CE** mode with **<MENU+ENTER>** keys. To check the unit's mode, just press **<MENU>** key. Display  indicates **CE** mode, otherwise the unit is in **CF** mode.

One Key functions, CF Mode only

<POWER> *Scroll Up* to previous Data or Stats location
<UNITS> *Scroll Down* to next Data or Stats location
<ENTER> Displays *hidden* last *digits* for Data or Stats value
<MENU> Go to *Menu Mode*, either Stats or Data Menu
<STATS> Set *Stats Mode* & Display current Stats
<DATA> Set *Data Mode* & Display current Data

To enter Stats Menu press **<STATS>** key first then **<MENU>** key.
To enter Data Menu press **<DATA>** key first then **<MENU>** key.

Errors & Alarms

Alarms are displayed as a flashing message. The message will flash for 10 seconds and then disappear. Pressing **<ENTER>** key acknowledges and clears the alarm. The **CF** mode has advanced alarm control settings; see **Stats Menu** (page 15). Flashing **dots** and flashing **colon** are special alarms that stay and indicate bad light conditions. They disappear only if you correct the problem, or turn the sensors Off by pressing **<MENU+UNITS>** keys.

- **Flashing colon:** sensors are Off, unit will not accept shots
- **Flashing decimal points:** calibration failed, bad conditions
- **Flashing decimal points & colon:** requires recalibration
- **Flashing last digit:** displayed number is greater than 9999.99, you must press **<ENTER>** key to see the rest of the number.

Battery Alarms

Battery alarm is activated when battery voltage goes below required value. It is acknowledged by pressing **<ENTER>**, or it times out. It comes on again when conditions change or timer, at 60-sec intervals, activates it again.

P r r 1 Battery power level is **Low**, performance will degrade

P r r 2 Battery power level is **Very Low** for normal operation

P r r 3 Battery is **Dead**, only data and stats review possible

Chronograph Alarms

Chronograph alarms always time out. These alarms may be turned **Off** by pressing **<MENU+UNITS>** keys.

[r r 1 **Front** sensor was missed

[r r 2 **Rear** sensor was missed

[r r 8 **Interference** encountered during shooting

[r r 9 **Muzzle blast** or interference.

Operator Errors

Operator errors come on when an illegal function is attempted. This is due to access violation, improper use of functions etc.

0 r r 1 **Undelete** shot **not possible**, trash bin empty or lost

0 r r 2 Memory is **not empty**, String is in use

0 r r 3 Action **not possible**

Setup Considerations

Archery Mode Notes

Archery mode is intended to be used for quiet firearms, that is, devices that are not very noisy. This mode does not affect high velocity projectile measurements, but high velocity firearms are loud and the noise may cause false triggering.

When using loud shooting devices, the chronograph has to be placed way back from the source of the noise. You may start with 10-feet, but increase the distance if muzzle blast still causes false readings or errors. This low-cost-unit has a limited capability for detecting muzzle blast.

Supersonic Firearms

Firearms with supersonic speeds do not affect archery mode. The projectile reaches the chronograph before the sound wave does, therefore it does not effect velocity measurements.

Indoors & Interference

Our “**True Archery mode**” works well in outdoors only. Nearby power lines, fluorescent lights, and other artificial light sources may affect archery mode. That is why we do not recommend it for indoor use.

The unit will detect indoor environment by analyzing power line interference and other man-made interference sources. Once this interference is detected, it will calculate the effect it may have on the velocity measurements. If the effect is significant, it will refuse to accept shots and a flashing colon-alarm will appear. Even if you attempt to fool the unit by taking it outdoors, calibrating it and then slowly bringing it indoors, it will still detect your attempt.

It is possible to use archery mode indoors if the power lines and electric appliances are at least 40 feet away and are properly shielded and there are no artificial sources of light in sight.

High Detection Capability

Archery mode will detect arrows and paintballs as high as 8 feet when the light conditions are good. This may be deceiving, because this chronograph is only guaranteed to meet the accuracy specified at 6 inches above the optical slots. It is quite possible that your unit may just be as accurate above 4 feet; however, we do not test for such capability. This is a low cost unit and it is only meant to function up to 12 inches above the optical slots. In the future we will provide precision units that will be accurate at more than 24 inches.

Our Archery vs Theirs

Our unit, whenever indoors or outdoors, outperforms anytime competing archery-chronographs even when set to normal mode. Here is a simple test to verify this fact.

Set our unit to normal mode (not archery mode), take both units indoors or outdoors and drag your hand over the optical slots at about 2.5 feet/sec. You will see that only our unit will detect your hand at such low velocity. This is only possible because of our innovative design that uses Adaptive Calibration.

The competing chronographs possess physically changed electronic components in their units to achieve a quasi archery mode. We, on the other hand, use digital control to achieve a true archery mode that can measure velocities as low as **2.5 f/s**.

Our unit is equivalent to two of the competing ones. When you need a true archery mode, it is available by pressing few keys. In **CF-Mode** you simply select it from a menu.

Special Features

There are two special features that require multiple keys.

<**STATS+DATA+MENU**> Hardware Reset, data may be lost
<**STATS+DATA+POWER**> Flip between **[ERR1]** and **[ERR2]** mode

When these keys <**STATS+DATA+MENU**> are pressed and <**DATA**> key is released *last*, the unit skips eDisk loading data and setup into memory. It will be confirmed with **[E=]**.

Flipping to **[ERR2]** mode enables extra functions. Default is **[ERR1]** mode. See menu section for details (page 17).

USA and Metric display identifiers

When <**UNITS**> key is pressed, display will identify units used.

[.ME.] Indicates Metric units are selected, *meters/sec*
[.FE.] Indicates USA units are selected, *feet/sec*
[.03.] Two dots on each side of 03 indicate *Metric velocity*
[.03] Absence of dots indicates *USA units* for *velocity*
[.Lo.] Two dots on each side of Lo indicate *Metric Stats*
[.Lo] Absence of dots indicates *USA units* for *Stats*

Archery mode control

When archery mode is changed, display will identify current mode. The keys to do this are <**ENTER+POWER+UNITS**>.

[Rfc0] Archery mode is turned *Off*.

[Rfc1] Archery mode is turned *On*.

Sensitivity Control & Muzzle blast

When sensitivity is reduced, muzzle blast has less effect on the unit. But reducing sensitivity also reduces accuracy. Factory setting is **70%**; it can be changed from **00%** to **95%** in steps of **5%**. The keys to do this are <**ENTER+UNITS**>. Fine adjustment, by **1%**, is only available from **CF** mode.

[LL80] Example of sensitivity set to **80%**

[LL35] Example of sensitivity set to **35%**

Two-key functions, CE & CF

This requires that you press two keys in sequence as shown in the table below. For example, <MENU+DATA> sequence requires that you press and hold down <MENU> key, and while you hold down <MENU> key, press <DATA> key. To end this function you must release both keys at the same time.

<MENU+ENTER>	Switch between CE & CF modes
<MENU+UNITS>	Turn sensors Off
<MENU+POWER>	Turn Power Off and Save data to eDisk
<DATA+STATS>	Find shot position for High or Low
<ENTER+POWER>	Display battery voltage , internal level
<ENTER+UNITS>	Set Sensitivity Level, 00% to 95%
<DATA+MENU>	Decrement String
<DATA+ENTER>	Increment String
<DATA+UNITS>	Select Units, f/s or m/s , CF only
<DATA+POWER>	Select Velocity or Temperature , CF Only
<STATS+MENU>	Decrement String, display its Stats
<STATS+ENTER>	Increment String, display its Stats
<STATS+UNITS>	Select Stats Units, f/s or m/s
<STATS+POWER>	Select Velocity or Temperature Stats .

Three & Four key functions CE & CF

This requires that you press all keys in sequence as shown in the table below. For example: <STATS+DATA+MENU> requires that you press and hold down <STATS> key then <DATA> key and finally <MENU> key. To end this function, release all keys at the same time.

<STATS+DATA+MENU>	Hardware reset , data may be lost
<ENTER+POWER+UNITS>	Set Archery On or Off
<ENTER+POWER+DATA>	Delete current shot
<ENTER+POWER+STATS>	Delete current string
<ENTER+POWER+MENU+DATA>	Undo Shot Delete
<ENTER+POWER+MENU+STATS>	Undo String Delete

Please note: all of these function are available from the **Stats** or **Data** menu. **CE** mode operates in data protection mode and has no access to **Stats** or **Data** menu. This prevents accidental setup or data changes.

Error Messages

The unit uses a multitask operating system and it continuously monitors all important parameters, such as light conditions, battery status, missed shots etc, while you are shooting. When something goes wrong, it reports the error by flashing a message on the display. Below are some of the possible messages that may be displayed. Urgent or Serious messages have to be acknowledged by pressing <ENTER> key. Less serious ones will flash for a while and then disappear.

Calibration Failure

When calibration fails because operator terminated the process or the conditions are bad, all decimal points on the LCD will start to flash.

To remedy this you must try again by turning the unit Off and On again. If this does not work, then you must read the section on <Calibrating the Unit>, page 23. You may have to remove the source of problem or provide sufficient light.

Setup Failure

Every time you fire a shot, the unit takes about 0.3 seconds to test and verify that there are no environment problems. If severe changes that will degrade performance have been detected, the colon starts to flash. The unit will then refuse to take more shots until you correct the problem and recalibrate it, by turning the unit Off and On. The unit will now perform a thorough test to verify that you can still use the unit with considerable reliability.

Low Battery

Battery level is continuously monitored and the following errors are displayed, indicating Power Errors. The message is displayed once and it is only redisplayed again if the conditions are changed.

Quick Reference

Prr1

Power level has dropped below 7.0 Volts. The unit's performance will start to degrade. You should consider replacing the battery.

Prr2

Power level has dropped below 6.0 Volts. The unit may still function but the results will not be accurate. You should only use the unit for Data retrieval and Stats review. You should change the battery.

Prr3

Power level has dropped below 5.3 Volts. The unit will not be able to calibrate properly. The battery is considered DEAD. You can only use it for Data and Stats retrieval. You **must** replace the battery at this point.

Please note that data retrieval and review section still functions with crisp clear display, even when the battery is considered dead. However, we recommend that you change battery, because below 3.95 volts you will begin to lose your data. Also, below 5 volts PC interface may not work with all PC's.

Velocity Capture

The unit will attempt to differentiate between real shot and muzzle blast or external interference. Because this is a low cost unit, detection of muzzle blast and external interference is not always 100% effective. Therefore, we have provided limited alarms that indicate when a shot has been misread,

[rrr1]

Front sensor was missed

[rrr2]

Rear sensor missed

[rrr8]

Environment interference

[rrr9]

External interference or muzzle blast detected

Adaptive Calibration

This unit **must be calibrated** before you start your shooting session, light conditions have changed, or it was relocated. Calibration is done by turning the unit **Off** and then **On** with **<POWER>** key. Calibration is over when flashing [RL] is displayed. If **decimal points** or **colon** appears, it indicates that calibration failed - see **Run Calibration** (page 23). When Adaptive Calibration is finished, you must **acknowledge** it by pressing **<ENTER>** or **<DATA>** key, otherwise the unit **will not work** and it will simply flash calibration results **forever**. CE-3 has an **Auto-Calibration** mode which is activated when **CE** mode is on or **PC Remote Control** is used. **Auto-calibration** mode will determine if environment is reasonable and enable the unit accordingly. Unit is **Auto-Ready** when calibration number with three bars is displayed. For example, if calibration number was **197**, then display will show [197].

Please note: this generation of **CE-3** has a limited intelligence, and therefore, it may not always detect transient environment problems. Also the unit works in light transmission, light reflection and infrared light mode so it will not give warnings for low light conditions.

To run calibration from **CF** mode, press **<MENU>** key then **<ENTER>**. In **CF** mode, adaptive calibration always runs in manual mode. After calibration is finished, you must press **<DATA>** or **<STATS>** key.

One Key functions, CE Mode only

<POWER> Turns the unit On or Off, unconditionally
<UNITS> Flips between meters and feet on the fly
<ENTER> Displays the hidden digits
<MENU> Displays model number, in CF Mode set menu mode
<STATS> Sets Stats Mode and reviews statistics
<DATA> Sets Data Mode and reviews shots, current string.

CE mode is a simple "**One key**" fully automated operation. It manages interference problems, adaptive calibration and data storage without user interference. For advanced features, please switch to CF mode: **<MENU+ENTER>** key.

Important Notes

Sensitivity Control & Muzzle blast

Sensitivity level may be reduced to lower the effect of muzzle blast and other noise. The range may be set from **00%** to **95%** in steps of **5%** for CE-3 and **1%** for CF-3. Lowering sensitivity reduces muzzle blast effect, but unfortunately, it also reduces accuracy. For muzzle blast reduction, it is better to move the unit farther back rather than reducing sensitivity. For loud firearm use **50%** setting. Archery, Paintball and other quiet devices use **80%**. Higher values, **85%** and up, require low Electromagnetic and Optical interference, only found in the countryside.

Turning off sensors and alarms

In order to save battery power, a special function, **<MENU+UNITS>** keys, has been provided to turn Off detection electronics and to stop environment alarms. Use this feature only when data and statistics review are needed. To activate velocity measurement again, you **must** calibrate the unit. From CE mode, turn the unit **Off** and **On**. If you fail to calibrate it, the unit will **stop** detecting shots. To check if sensors are turned Off, press **<MENU>** key; this activates pending warning and alarms.

Change Battery without losing data

Turn the unit **Off** for about 30 seconds. While the unit is **Off** you must **not touch** any of the **keys**. The system will stay alive in hibernation, without battery, at room temperature, from **2** to **20 minutes**. You have about **2** minutes to replace the **old** battery with a **new** one. If the battery is reversed, you do not lose data, damage the unit or the battery. The battery must still be replaced **correctly** within **2** minutes.

Flashing colon or flashing decimal points

Flashing colon or decimal points indicate that the unit will **no longer accept shots** because environment conditions have changed. You can turn sensors off and use the unit for data review only, or you can calibrate it again. Please note that the unit **will not accept shots** unless it is **calibrated** again.

Memory Overflow

Memory overflow alarm is turned Off as a default. If you need memory-full alarm, it may be turned On from **Err2**..**Err7** menu. This alarm does not work if Circular String Mode from **Str0**..**Str7** is turned On, because the length of string can not be determined. In non-Circular mode, a flashing error message is displayed to indicate that string is about to overflow and data loss will occur.

Err0 There is no more room in the string, data will be lost

Err1 There is room in the string for one more shot.

Operator

Operator entries are monitored and when an invalid operation is performed, you will get one of the following messages:

Err1 Undelete shot not possible because there are no deleted shots in trash bin.

Err2 String or Folder is in use.

Err3 This Action not allowed here

Troubleshooting

Dead Unit

If nothing happens when you replace the battery, please check the following:

- Measure the battery voltage, make sure the battery is installed correctly and not reversed.
- To make sure the unit boots up properly when you have problems, press and hold down the **<POWER>** key for 30 seconds. You do this with the **battery removed**.
- The battery voltage must be at least 4.6 Volts. The unit will not function as a chronograph with such a low battery, but it may be used for data retrieval and stats review.
- The battery may show much more than 4.6 volts on the voltmeter when measured without a load. Once battery is installed, the load may bring the voltage below 4.6 volts and it shows up as a black display, quickly disappearing.
- Please note that the chronograph will not detect velocities properly if the battery voltage is below 7.00 volts under load. The unit will begin flashing power level alarms.

Flashing Decimal Point

If all **decimal points** are flashing, it means that the unit will not detect velocities unless it is calibrated again. The calibration is done by turning the unit **Off** and **On** again. If you want to use the unit just for data retrieval and stats review, then you should turn sensors **Off** by pressing **<MENU+UNITS>** key.

Flashing Colon

When **colon** is flashing, it means that the environment is not suitable for velocity measurements and you must recalibrate the unit. If sensors have been turned Off, flashing colon will stop after you begin stats or shots review.

The unit will however remind you every 60 seconds that it needs to be calibrated again. The reminder will be flashing colon which can be suppressed for another 60 seconds by a simply executing stats or data review.

Statistics List	34
Percent Standard Deviation (Pd)	35
Menu & Model number <MENU>	37
Lower digits view <ENTER>	37
Extended Digits	37
Next Shot & USA-Metric Conversion <UNITS>	38
Previous Shot & Turn Unit On-Off <POWER>	39
EXTENDED KEY FUNCTIONS	40
Battery power level <ENTER+POWER>	40
Sensitivity Level <ENTER+UNITS>	40
Delete shot <ENTER+POWER+DATA>	41
Undo Deleted Shot <ENTER+POWER+MENU+DATA>	42
Clear String <ENTER+POWER+STATS>	42
Undo Clear String <ENTER+POWER+MENU+STATS>	43
Data Recovery	43
Sensors Off <MENU+UNITS>	43
Switch between CE and CF mode <MENU+ENTER>	44
Find Stats-Shot <DATA+STATS>	44
Increment String <DATA+ENTER>	44
Decrement String <DATA+MENU>	45
Cross String Stats <STATS+ENTER> & <STATS+MENU>	45
POWER-UP FEATURES	46
SETUP CONSIDERATIONS	47
Archery Mode Notes	47
Supersonic Firearms	47
Indoors & Interference	47
High Detection Capability	48
Our Archery vs Theirs	48
ERROR MESSAGES	49
Calibration Failure	49
Setup Failure	49
Low Battery	49
Velocity Capture	50
Memory Overflow	51
Operator	51
TROUBLESHOOTING	52
Dead Unit	52
Flashing Decimal Point	52
Flashing Colon	52
Unit will not Calibrate	53
SPECIFICATIONS	54
WARRANTY	54
INDEX	55

Table of contents

WARNING	3
LIABILITIES	3
IMPORTANT NOTES	6
QUICK REFERENCE	7
Adaptive Calibration	7
One Key functions, CE Mode only	7
Two-key functions, CE & CF	8
Three & Four key functions CE & CF	8
Special Features	9
USA and Metric display identifiers	9
Archery mode control	9
Sensitivity Control & Muzzle blast	9
Errors & Alarms	10
Displayed value has no decimal point	11
CF mode	11
One Key functions, CF Mode only	11
CF MENU.....	12
Menu Movement and Control keys	12
DATA Menu list	13
STATS Menu list	15
STATISTICS LIST	17
QUICK START	19
Reset & First Time Power On.....	20
Verify Operation	20
Quick setup	21
Indoors Setup	22
Outdoors Setup	22
Run Calibration	23
Indoors Calibration results	24
Outdoor Calibration results	25
Calibration failed	26
Muzzle Blast	27
High value readings, flashing last digit	27
GETTING STARTED	28
How the chronograph works	29
Light source required	30
Fluorescent lights.....	30
Incandescent lights	30
Light Diffusers	31
BASIC KEY FUNCTIONS.....	32
Data Mode <DATA>	33
Stats Mode <STATS>	34

Unit will not Calibrate

All dots are flashing, indicating that the unit failed to calibrate.
There are three possible conditions,

- **Battery is dead.**
The voltage is below 7.0 volts under load.
Check battery power level with **<ENTER+POWER>** keys; it should be greater than 34%.
- **Indoors.**
Fluorescent or sodium lamps are nearby, reflecting off the ceiling and walls.
Artificial lights may be too strong and are shining directly into the optical slots; try using diffusers.
There may not be enough light; you must provide some light.
The unit is in Archery mode. Archery mode does not work well indoors; see **“Archery On-Off”** and **“Archery Notes”**.
- **Outdoors.**
If you have Archery mode **On**, try switching it **Off**; see **“Archery On-Off”** function.

Sky is very blue and you are in Archery Mode. Under very deep blue sky, archery mode may not be able to calibrate.

When in archery mode, moving tree branches above the chronograph will be interpreted as an unstable environment.

Specifications

Computational Range	1.00 to 80,000.00	Feet/Sec
Applications Range	2.00 to 9,999.00	Feet/Sec
Accuracy, Low speed 6.0" above the sensors 2.5 f/s to 999 f/s	0.3	%
Accuracy, High speed 6.0" above the sensors 999 f/s to 10,000 f/s	0.5	%
Clocking Frequency	12,000,000	Hz
Shooting Area Low speed range, 2.5 f/s to 999 f/s	60	Inches Square
Shooting Area High speed range, 1000 f/s to 10,000 f/s	20	Inches Square
Operating Temperature Battery > 7.0 Volts	- 20 to + 50	Degrees Celsius
Operating Temperature Battery > 7.0 Volts	- 4 to + 120	Degrees Fahren- heit

Warranty

This product is warranted against all manufacturing defects for the period of 3 years. If the product is found to be defective, please return it directly to us for repair or replacement.

Warning

Before you use this product you must follow all safety instructions as recommended by manufacturer of your firing device, no matter what that device may be. Irrespective of who the manufacturer of your firing device may be, you alone are ultimately responsible for using correct safety precautions. You should not use this product to get combustion pressure for your firearm.

Liabilities

This product is a passive optical instrument. It does not emit any microwave radiation in order to measure projectile velocities.

It is your sole responsibility to safeguard yourself and other people against any injury or property damage when firing projectiles near the unit or accidentally into the unit. You must not use this product to determine firearm combustion pressure.

This product relies heavily on complex hardware, software and operating system. Because of its complexity, a finite probability exists that a software module or a hardware component may fail to function as intended. This failure may result in a loss or change of data which could produce erroneous velocity measurement. For example, a simple LCD-element failure may display number **8** as number **9** or **6**. There are thousands of other possible failure modes; therefore this product is not a fail-safe. If fail-safe velocity measurements are required, then this product must not be used without our written approval. Approval requests will be considered only if setup is based on "multi-chronograph-majority-vote design" and it must be accompanied by failure analysis.

We assume no responsibility for the injury to any person or persons whether it is consequential or inconsequential as a result of using this product. We also assume no responsibility for the damage to any property or loss of profit as a result of using this product.

This product and all its associated hardware and software design are ©Copyright property of eChrony inc.

If you do not agree with any of the above statements, you must immediately return this product in its original condition to the place of purchase for a full refund.

CE-3 Main Features

- 2 Modes of operation, simple **CE** mode and an advanced **CF** mode.
 - **CE** mode is easy to use, **single-key** operation.
Just turn it on and wait for Auto-Calibration. When your work is done, turn the unit off and your data is saved automatically.
CE mode **does not use eDisk** for permanent data storage.
 - **CF** is a **75-function, menu driven** mode, **it uses eDisk**.
- Flip between **CE** & **CF** mode by pressing **<MENU+ENTER>**.
- Special **CAM mode** enables **10 extra functions**.
- To protect data, **eDisk-Off** option is available from **CAM mode**.
- In **CF mode** Data is automatically **Saved/Retrieved** to/from eDisk.
- CE-3 has a **40 shot** volatile memory divided in **4 to 10 Strings**.
- CE-3 has a small **eDisk** drive for **400 shots** divided into **10 folders**.
 - eDisk holds data **without battery** for up to 40 years.
 - eDisk is divided into 10 folders with 40 shots each.
- **Remote Control** via PC Interface using plain **ASCII** readable text.
Baud rates **300 to 4800-b/s**, 3-wire cable, maximum **200-feet** long.
OS independent Interface - **RS232/TTY/Terminal**.
Import data to any **Spreadsheet** or **Data Base** with **ASCII** format.
Macros provided for **Microsoft Excel** data import & some stats.
- **Elapsed time** between shots transmitted to the PC: +/- 0.001 sec.
- **Download** data to PC; single String, single Folder or an entire eDisk
- **Alarms** for: low battery, missed or bad shots, memory full etc.
- Ambient **Temperature Recorded** with each shot.
- **Velocity** and **Temperature Synchronized** at all times.
- View **Statistics** in **Real time** as you shoot. **Available Stats** are
Low, High, Average, Extreme spread, Standard Deviation,
Percent STD, Power Factor, Energy.
- Change **Units** on the fly from Stats or Data mode.
- Select **USA** or **METRIC** system with **One Time Conversion** view.
- **Bullet mass** entry, **0.005 to 40.950 gm** or **0.077 to 631.95 grains**.
- **Power factor** in **grain-f/s** or **grams-m/s**, **Energy** in **joules**.
- View **Cross String Statistics** by scrolling from string to string.
- Scroll **up** and **down**, **Shot** to **Shot**, in Data or Stats mode.
- Scroll **left** and **right**, **String** to **String**, in Data or Stats mode.
- Scroll **forward** and **backward** from **Folder** to **Folder**.
- **Delete Shot** & **Undelete Shot**.
- **Delete String**, **Undelete String** & **Old Data restore**.
- **Delete Folder** & **Undelete Folder**.
- Auto **Power Down**, User selectable from **1 min to 4 hours** or **none**.
- Real time **Ambient Temperature** display in **Celsius** or **Fahrenheit**.
- Real time **Battery Voltage** display for internal load conditions.
- User selectable **Sensitivity level** control for **Muzzle blast**.
- **Adaptive Calibration** to detect environment interference.
- **Super Archery** mode, user selectable.

Index

Adaptive Calibration.....	7	Memory Errors.....	11
Adaptive Calibration.....	23	Memory Overflow Errors.....	51
Archery mode	9	Menu & Model number	37
Archery Mode Notes	47	moving shadows.....	29
Archery On-Off	46	Muzzle Blast.....	27
Basic Key Functions	32	Next Shot & Units select f-m.....	38
Battery	49	No decimal point.....	11
Battery Alarms	10	Operator errors.....	51
Battery power level	40	Operator Errors	10
Battery voltage.....	19	Our Archery vs Theirs	48
Calibration failed	26	Outdoor Calibration	25
Calibration Failure	49	Outdoors Setup	22
Calibration Status Results	18	Percent STD.....	35
CE One Key functions	7	Power-Up Features	46
CE-3 Main Features.....	2	Previous Shot & Power On/Off ..	39
CF Menu.....	12	Quick Reference.....	7
CF One Key functions.....	11	Quick setup	21
Chronograph Alarms.....	10	Quick start	19
Clear string	42	Reset & Power On.....	20
Cross String Stats.....	45	Returning the unit	57
DATA Menu list.....	13	Run Calibration.....	23
Data mode	33	Sensitivity & Muzzle blast.....	9
Data Recovery.....	43	Sensitivity level.....	40
Dead Unit	52	Sensors Off	43
Decrement String.....	45	Setup Considerations	47
Delete shot	41	Setup Failure	49
detect muzzle blast.....	27	Special Features	9
Errors & Alarms	10	Specifications	54
Errors Messages	49	Statistics Description	34
Extended Digits	37	Statistics List	17
EXTENDED FUNCTIONS	40	Statistics List	34
Find Stats-Shot.....	44	STATS Menu list	15
First Time User	28	Stats Mode	34
Flashing Colon.....	52	String Stats-Compare.....	45
Flashing Decimal Point.....	52	Supersonic Firearms	47
Fluorescent lights	30	Switch to CF mode	44
Getting Started	28	Table of contents.....	4
High Detection Capability	48	Technical support.....	57
High value readings	27	Three & Four key functions	8
How chrono works	29	Troubleshooting.....	52
Important Notes	6	Two-key functions	8
Incandescent lights.....	30	Undo cleared string	43
Increment String	44	Undo deleted shot	42
Indoors Calibration	24	Unit will not Calibrate.....	53
Indoors Setup	22	USA and Metric mode	9
Liabilities.....	3	Velocity Capture Errors	50
Light Diffusers.....	31	Verifying Operation	20
Light source required	30	Warning.....	3
Low Battery Errors.....	49	Warranty.....	54
Lower digits view	37		

CHRONOTAR.COM

Address

Chronotar Micro

936 Monte Carlo Court, Suite #4
Mississauga, Ontario,
Canada, L5C-3M1

Telephone 416-223-7862

Fax 416-223-7862

E-mail

ce@chronotar.com

Returning the unit

Before returning the unit, you must give us a call to obtain return instructions or visit our website and click on Returns menu. You can also contact us vial email at return@chronotar.com.

Technical support

If you have any problem with the unit, even a minor one, please let us know. You can either, call us, email a note to help@chronotar.com, or contact us directly via our website. Just click on Contact Us menu.

Main Website

<http://www.chronotar.com>

©Copyright echrony inc, 2004/2005

USER'S MANUAL

CE-3 CHRONOGRAPH Version 1.01

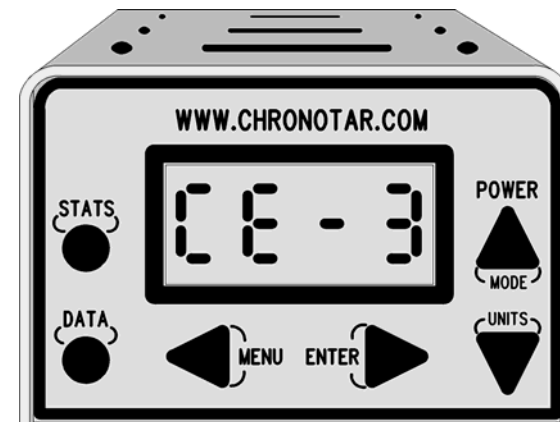

For Quick Reference
see page 7

Latest manuals and software releases
are available from
<http://www.chronotar.com>
<http://www.echrony.com>